

DETTAGLIO
SCALA 1 : 10

DETTAGLIO
SCALA 1 : 2

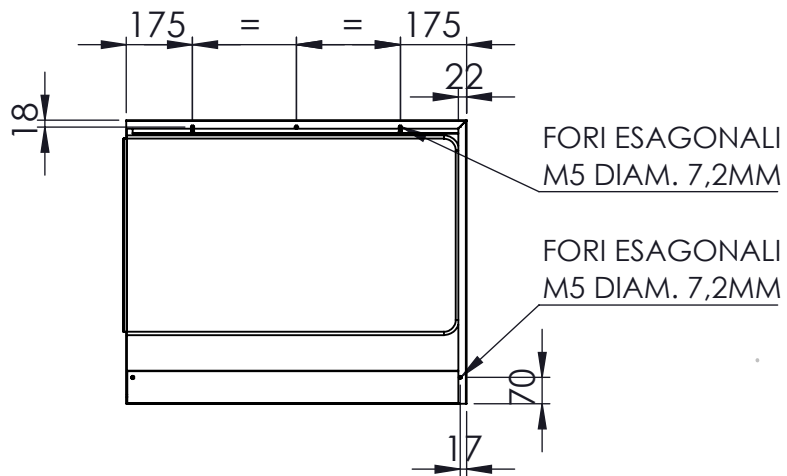
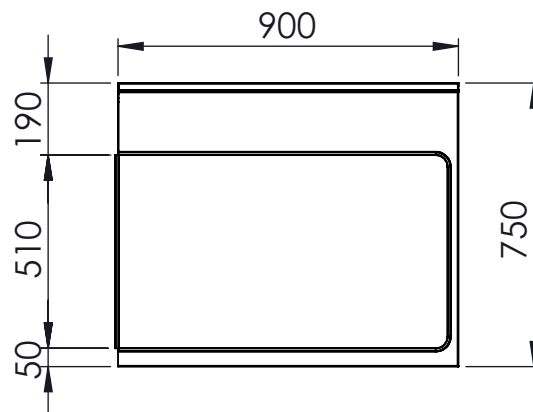

DISEGNATO	
DATA	18/01/2024
PESO	10042.68

CODICE: **MU00**



CONFIGURAZIONE: **L:900 P:750**

SCALA: 1:20

A4

FOGLIO 1 DI 1